

Auftrag:	
Datum:	
Unterschrift Kunde:	

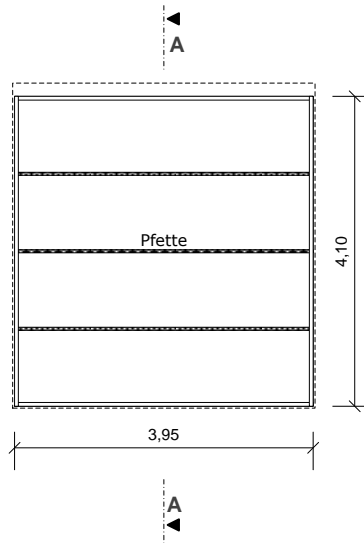

Grundriss



Vorderansicht

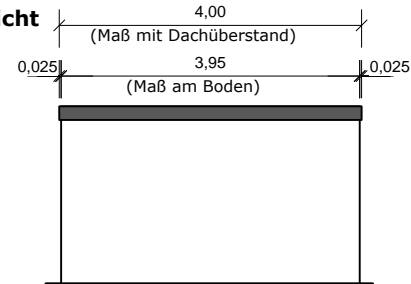

Rückansicht



Seitenansicht links

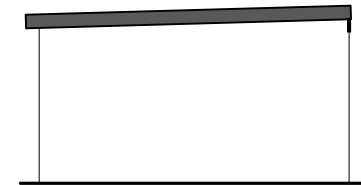

Seitenansicht rechts

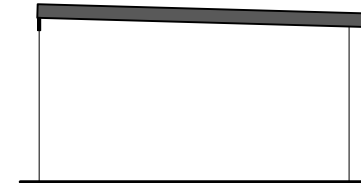

Schnitt A-A

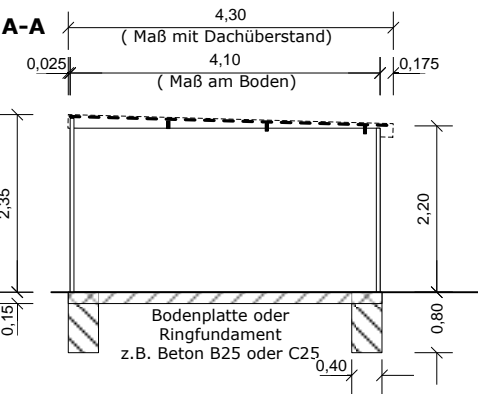

Gerätehaus Typ URBAN ONE 3950 x 4100 mm,
M 1:100, Maßangabe in Meter

Dach und Wände in Stahlelementbauweise. Wände außen verputzt.

