

Auftrag:	
Datum:	
Unterschrift Kunde:	

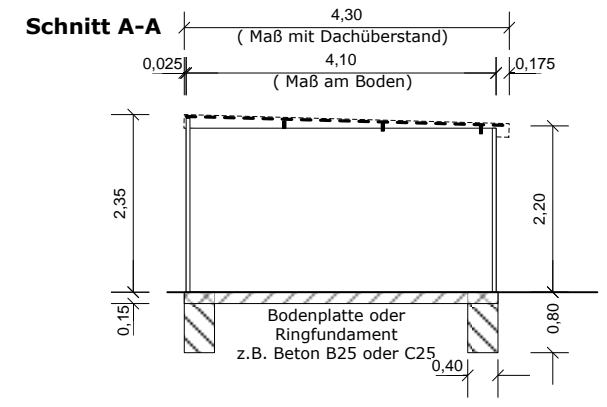

Gerätehaus Typ URBAN ONE 2500 x 4100 mm,  
M 1:100, Maßangabe in Meter

Dach und Wände in Stahlelementbauweise. Wände außen verputzt.

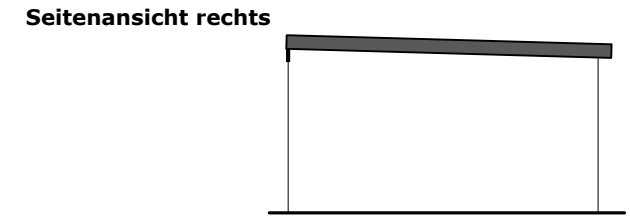
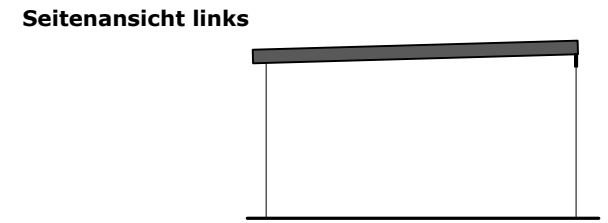
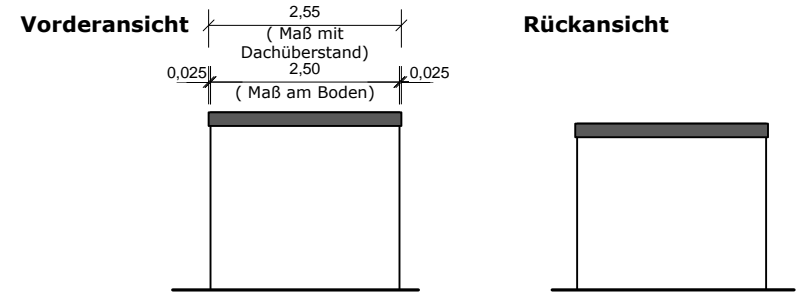
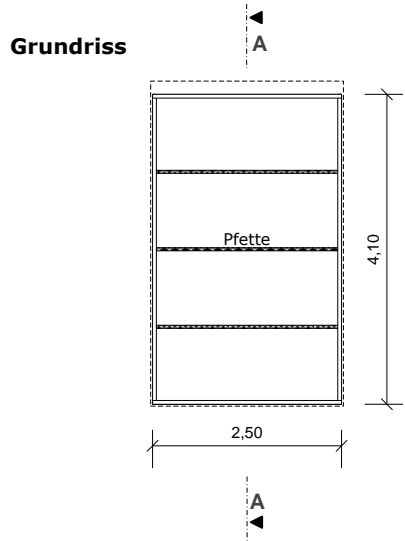